

Your Old House Was Designed to be Energy Efficient and Was Built to Last!

We've all heard about old, leaky buildings that waste energy but, in fact, builders of yesteryear relied on durable natural materials and architectural features that required minimal, but routine, maintenance. For example, roof overhangs and open decorative porches were designed to provide shade; operable windows and doors to allow for daylighting and natural ventilation; wood windows, siding and trim were fabricated from dense, old growth species not only to resist rot, but also to facilitate simple repair.

You will be surprised how cost-effective combining historic preservation and new technology can be, and how much work you can do yourself or with the assistance of a skilled contractor! Think of your house as a long-term project; allocate a number of dollars and hours for work each month. Our toolkit offers an overview of what can be done, and recommends resources to help you evaluate the most economical approach in terms of short- and long-term payback of energy dollars.

Preservation and energy efficiency are compatible goals. Energy saving priorities include:

Priority #1: Heating, Ventilation and Air Conditioning (HVAC) Be sure that your equipment is working as efficiently as possible. If you need to select a new system, consider how its installation will impact the building's historic fabric, and ask your local preservation experts for guidance. A number of NYS agencies have programs to assist with upgrading mechanical equipment and energy audits.

Visit: www.energystar.gov/index.cfm?c=home_improvement.hm_improvement_index

Priority #2: Insulation The best return on your investment in conserving energy is to insulate your attic. **Over 30%** of heat loss occurs through your roof! A layer of insulation in your attic can reduce that heat loss significantly.

Priority #3: Windows Despite the fact that they get a bad rap, windows account for only 5-10% of energy lost, primarily by air infiltration. Be sure your windows fit tightly by repairing them and adding weatherstripping, interior or exterior storms and interior window treatments.

Open porches, deep roof overhangs, and operable windows were built so that continued operation was possible by following simple maintenance practices.

Simple measures will retain the qualities found in historic materials and features, unlike some modern replacement materials which often fail within 20-30 years after installation. Roof overhangs and decorative porches provide shade, operable windows and doors provide light and ventilation, and siding and trim were fabricated from durable natural materials that required little maintenance.

ENERGY AUDIT To understand how to improve your heating and cooling systems, contact the New York State Energy Research and Development Authority (NYSERDA) office or a local auditor with historic building experience.

The results will determine the payback while retaining the features of your home.

CHIMNEY 14% of air escapes from the house through the fireplace. A wood fire will help reduce your heating costs. Be sure to close the damper when the fireplace is not in use!

FURNACE Is your furnace original to the house? Upgrade and take advantage of state and Federal grants and tax incentives!



WINDOWS & DOORS Retain & Renovate:

Don't Replace! Windows are character-defining elements. 10% of air leakage occurs at windows. Improve the performance of your windows by re-glazing and adding weather-stripping to reduce air exchange. The average window replacement project lasts 20 years at a cost of \$4,000.

Summer Cooling Employ window and door screens during the warmer months. During the day, close windows and curtains. Overnight, open the windows and doors. If you have double hung windows, open both the bottom and top sashes.

Air Infiltration & Insulation Heat loss occurs at doors, windows, and cracks in the building. Add weather-stripping to doors and windows and

caulk cracks. A good place to start is where the exterior walls meet the foundation walls.

Storm Windows Install storm windows to preserve your historic windows. Interior or exterior storm windows will increase the thermal performance of your home.

Doors Install door sweeps on the bottom of your doors to lock out the cold air.

WHAT CAN YOU DO ABOUT YOUR OLD WINDOWS?

Windows come in many shapes, sizes, and materials. Your windows were probably specially designed for the type of house you have—they are “character-defining” features that are a key aspect of both the exterior and interior design of the building. If you have an old house, your windows may already have lasted a century and with some care could last another! Most new windows can’t make the same claim. **TAKE CONTROL!**

You’ll find useful guidance at the National Park Service website: www.nps.gov/history/hps/tps/topics/index.htm and at the resources listed on the back page of this brochure. Before you decide how to approach your windows remember:

Replacing windows is one of the last options that owners of historic and older dwellings should consider for energy improvements. Repairing and caulking your existing windows, adding an extra pane, installing storm windows or adding interior treatments for efficiency—blinds, shades, curtains—are all practical, cost-saving measures that have a relatively short payback period on your investment. The cost outlay for replacement windows is very high and the payback very low for a very long return. In some cases, replacement windows will need to be replaced again long before energy savings equal their cost.

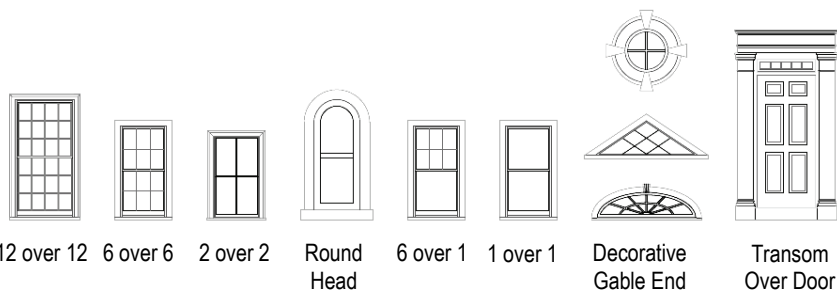

Windows common to historic homes; many are specific to particular styles of architecture.

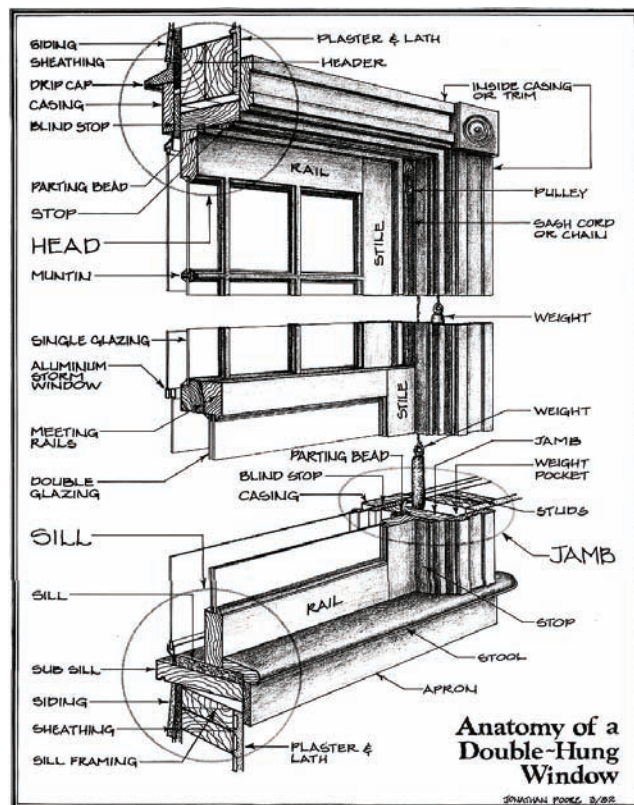

Old windows are made up of many components, each of which can be repaired, or removed and replaced with a little knowledge. Most new windows are singular and often require either wholesale replacement or replacement of complete sash.

(Courtesy of Old House Journal)

Common Problems

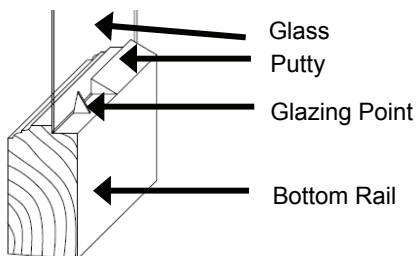
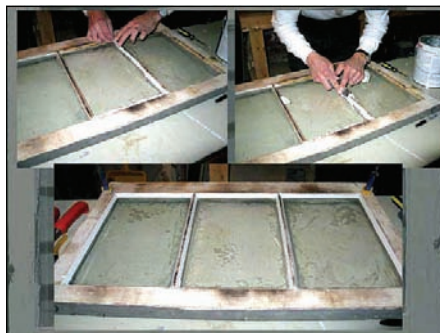
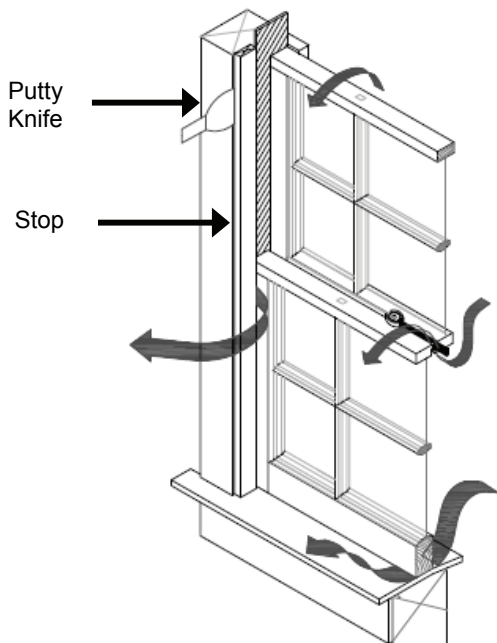

Sticky Windows / Loose Windows: Use a thin putty knife to slip behind the stop and lightly pry (you may need to run a knife along the edge on heavily painted trim). Simply loosening old paint will ease the motion, but some people apply furniture wax in the jamb channel to further reduce friction. Install weatherstripping to tighten.

Replacing Glazing and Putty: Brush rabbets with oil-based primer prior to inserting the glass pane gently in place. Reinstall metal glazing points. Create a long strand of putty and press it along the muntin to make a beveled edge. Allow putty to cure before painting. Links to a video demonstration can be found at: www.preservationnation.org/issues/weatherization/windows



Repainting: Remove built up paint by scraping or using chemical peels. (For information about working with lead-based paint, see the Environmental Protection Agency website: www.epa.gov/lead/pubs/renovation.htm.)

Prime and paint sash after removing from the window opening to avoid sealing the window shut. Paint frame and trim separately and allow to dry. Be sure to match your brush to the type of paint you are using.

(Photo courtesy of LC)

Routine Maintenance



+



While repairs to wood windows may be labor intensive, they are relatively uncomplicated. If you do it yourself, you can save money by repairing all or part of the windows. A round of simple maintenance and minor repairs could pull your old windows through another decade and more! The repair of common problems, including sticky windows, broken sash cords, cracked panes, and failed paint, are fairly simple procedures.

The key to successful planning for window maintenance is to consider the needs of each window. You don't need to do the same thing to all the windows in the house or building.

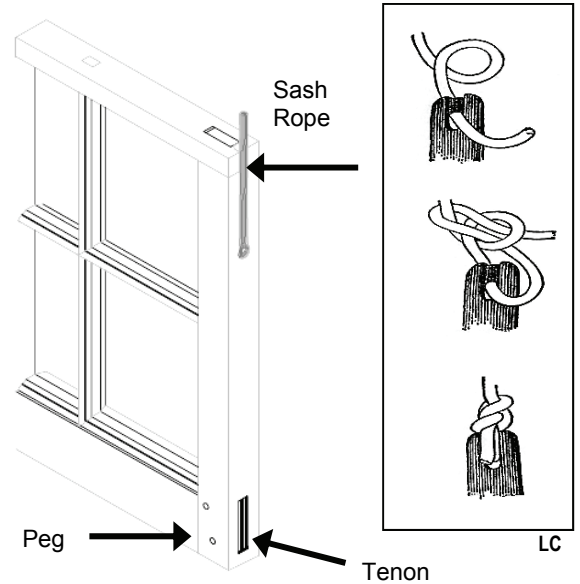

For example, you might carefully restore the front windows and add interior storm panels in the winter months. On the sides, weatherstripping and exterior storms could suffice. Whereas, on the rear of the house where multiple modifications may have been made, replacement windows might be appropriate. YOU DECIDE...don't let a contractor or salesperson talk you into wholesale replacement when it isn't necessary.

Create a window survey. Make a spreadsheet listing all your windows and doors: rate their physical condition (poor, fair, good, excellent); note missing elements, broken cords or panes of glass; the ease of operation; and integrity of paint. A survey will help you quantify the type and amount of work, gather costs, and establish a plan of action.

Sash Cords and Weights: A broken sash cord will require you to remove the window from the opening to access the sash pockets. Remove the stop then the sash, replace the cord and reattach it to the weight. A link to a good video demonstration can be found at: www.preservationnation.org/issues/weatherization/windows

(LC—images courtesy of Landmark Consulting Albany, NY)

Weatherization: Weatherstripping

Weatherstripping is the easiest way to keep your old windows and doors efficient and draft-proof. While today's window manufacturers would have you believe that insulation value is the more important factor, studies have shown that restricting air movement between the interior and exterior will ultimately save more money. *Heat loss by convection is minimal even in single pane windows.* Cold air can enter your house through any crack or opening. Some air infiltration is healthy, but too much can lead to wasted energy.

The National Trust for Historic Preservation has excellent guidance on their website: www.preservationnation.org/issues/weatherization/windows/

It is important to seal the locations where the sill plate meets the foundation, where different materials meet, as well as where utilities such as cable and gas lines pass through exterior walls.

A Weatherstripping should be installed at the jambs, the sill, the head and at the meeting rails. Use a thin putty knife to slip behind the stop and lightly pry off. This will allow you to remove the sash and install spring bronze.

B Spring bronze is a good choice for the jambs. The strip is nailed to the jamb channel along the interior side at the stop or parting bead. (Courtesy of LC)

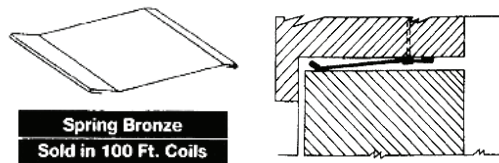

C An interlocking strip is best for the meeting rails. When the window is closed, the strips close off any air gaps. The sash lock pulls the meeting rails tight. (Courtesy of LC)

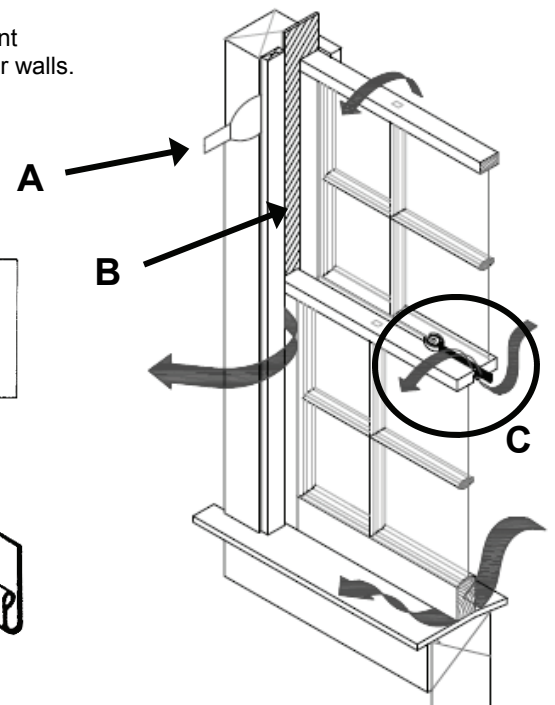
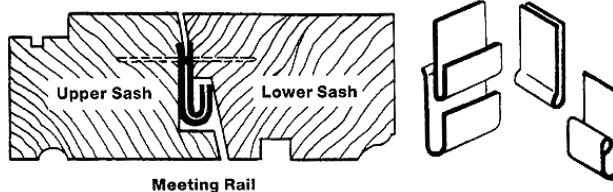

Storm Windows

If your windows are in reasonable condition, extra glazing can be added by installing storm windows, either on the interior or the exterior. Storm windows, or secondary glazing, provide a thermal barrier that prevents both heat from within being lost and cold from without being allowed in. Some studies show a 50% improvement in reducing energy loss. Storms are a very cost-effective way to save energy dollars.

Not only do storm windows create an insulating air gap, they are also effective in sound reduction, they protect historic building fabric and limit UV light which can fade fabrics and damage other valuable materials. Storm window panels can be made of glass, plastic or even plastic film; frame materials can be wood, aluminum/steel and vinyl.



Exterior, custom-made wood storm windows.
(Courtesy of LC)

Storms can be bought new, your existing storms can be cleaned and re-weatherized, or you can even find old storms at your local parts warehouse to rehabilitate.

The panels can be installed either on the interior or exterior of the historic window sash.

Replacement Windows

The retention of original or existing windows is most desirable; however, there may come a time when the deteriorated condition of a window clearly indicates replacement. The selection of replacement windows should begin with a study of the windows which are being replaced. Try to understand what your windows contribute to the appearance of your house including,

- Pattern of the openings and their size, shapes and decorative details
- Proportions of the frame to sash
- Configuration of window panes and muntin profiles
- Material, including type of wood or metal and glass characteristics

Once you have an understanding of the significance of your windows, search for a replacement that retains a much of the historic character as possible. You may want to seek out alternative sources to the big box home improvement stores, including local and state historic preservation offices, historic parts warehouses, restoration carpenters and other woodworking professionals.

While it is best to replace in-kind, there are substitute materials which can be employed to mimic your original windows. Again, wholesale replacement is not always the best approach.



Original 6 over 6:
Replace in kind keeping muntin pattern and size



Replacement 1 over 1:
Poor selection. No muntins reduces character of original windows.



Replacement:
Poor selection. Wrong size and proportion.

Recommendations for consultants and skilled contractors are available through your local and regional historic preservation organizations



For information about weatherization, historic preservation and tax credit programs contact your technical assistance representative at the

**Division for Historic Preservation
NYS Office of Parks, Recreation and Historic Preservation
518.237.8643 www.nysparks.com/shpo**

**Adirondack Architectural Heritage
(518) 834-9328 www.aarch.org**

**Landmark Society of Western New York
(585) 546-7029 www.landmarksociety.org**

**Preservation League of New York State
(518) 462-5658 www.preservenys.org
Staff can provide more information about local resources.**

**Preservation Buffalo-Niagara
(716) 852-3300
www.preservationbuffaloniagara.org**

**Historic Albany Foundation
(518) 465-0876 www.historic-albany.org**

National Park Service, Technical Preservation Services, section on weatherization www.nps.gov/history/hps/tps/weather/index.html

**New York Landmarks Conservancy
(212) 995-5260 www.nylandmarks.org
The NYLC has published *Repairing Old and Historic Windows*.**

The National Trust for Historic Preservation has excellent guidance on their website:
www.preservationnation.org/issues/weatherization/

**Society for the Preservation of Long Island Antiquities (SPLIA)
(631) 692-4664 www.splia.org**